



User Manual

Optical Convertor

Ref. 4031 – 4032 – 4033 - 4036

CONTENTS

1. INTRODUCTION	3
Product description REF 4031	3
Product description REF 4032	3
Product description REF 4033	3
2. INSTALLATION OF THE HARDWARE	4
3. TECHNICAL SPECIFICATIONS REF 4031	8
4. TECHNICAL SPECIFICATIONS REF 4032	9
5. TECHNICAL SPECIFICATIONS REF 4033	10
6. CHANNEL PLANS	11
7. SAFETY INSTRUCTIONS	12
8. CONDITIONS OF WARRANTY	13

No part of this manual may be copied, reproduced, transmitted, transcribed or translated into any language without permission.

Unitron reserves the right to change the specifications of the hardware and software described in these manuals at any time.

Unitron cannot be held liable for any damages resulting from the use of this product. Specifications are subject to change without notice. 11/23

© Unitron NV - Frankrijklaan 27 - B-8970 Poperinge - Belgium

T +32 57 33 33 63 F +32 57 33 45 24

sales@unitrongroup.com

www.unitrongroup.com

1. INTRODUCTION

Product description REF 4031

DSCR/LEGACY TWIN FTU

- optical wavelengths: 1310nm (V) + 1330nm (H) + 1550nm (T)
- optical input level: -12 to +0 dBm
- 3 outputs (2 dSCR/legacy/CATV. + 1 CATV.)
- AGC on all output ports
- signal quality indicator per wavelength
- Sky compatible
- can be used in systems with up to 64 splits

Product description REF 4032

DSCR/LEGACY QUAD/QUATTRO FTU

- optical wavelengths: 1310nm (V) + 1330nm (H) + 1550nm (T)
- optical input level: -12 to +0 dBm
- 5 outputs
 - Quad mode: 4 x dSCR/Legacy + CATV.
 - Quattro mode: VI, HI, Vh, Hh, CATV (serves as satellite output trunk)
- AGC on all output ports
- signal quality indicator per wavelength
- Sky compatible
- can be used in systems with up to 64 splits

Product description REF 4033

QUATTRO FTU

- optical wavelengths: 1350nm (V) + 1370nm (H) + 1550nm (T)
- optical input level: -12 to +0 dBm
- 5 outputs: Quattro mode: VI, HI, Vh, Hh, CATV
- AGC on all output ports
- signal quality indicator per wavelength
- Can be used in systems with up to 64 splits

Product description REF 4036

QUATTRO FTU

- optical wavelengths: 1310nm (V) + 1330nm (H) + 1550nm (T)
- optical input level: -12 to +0 dBm
- 5 outputs: Quattro mode: VI, HI, Vh, Hh, CATV
- AGC on all output ports
- signal quality indicator per wavelength
- Can be used in systems with up to 64 splits

2. INSTALLATION OF THE HARDWARE

RTV-SAT distribution over Fiber Optic Network (up to 64 splits)

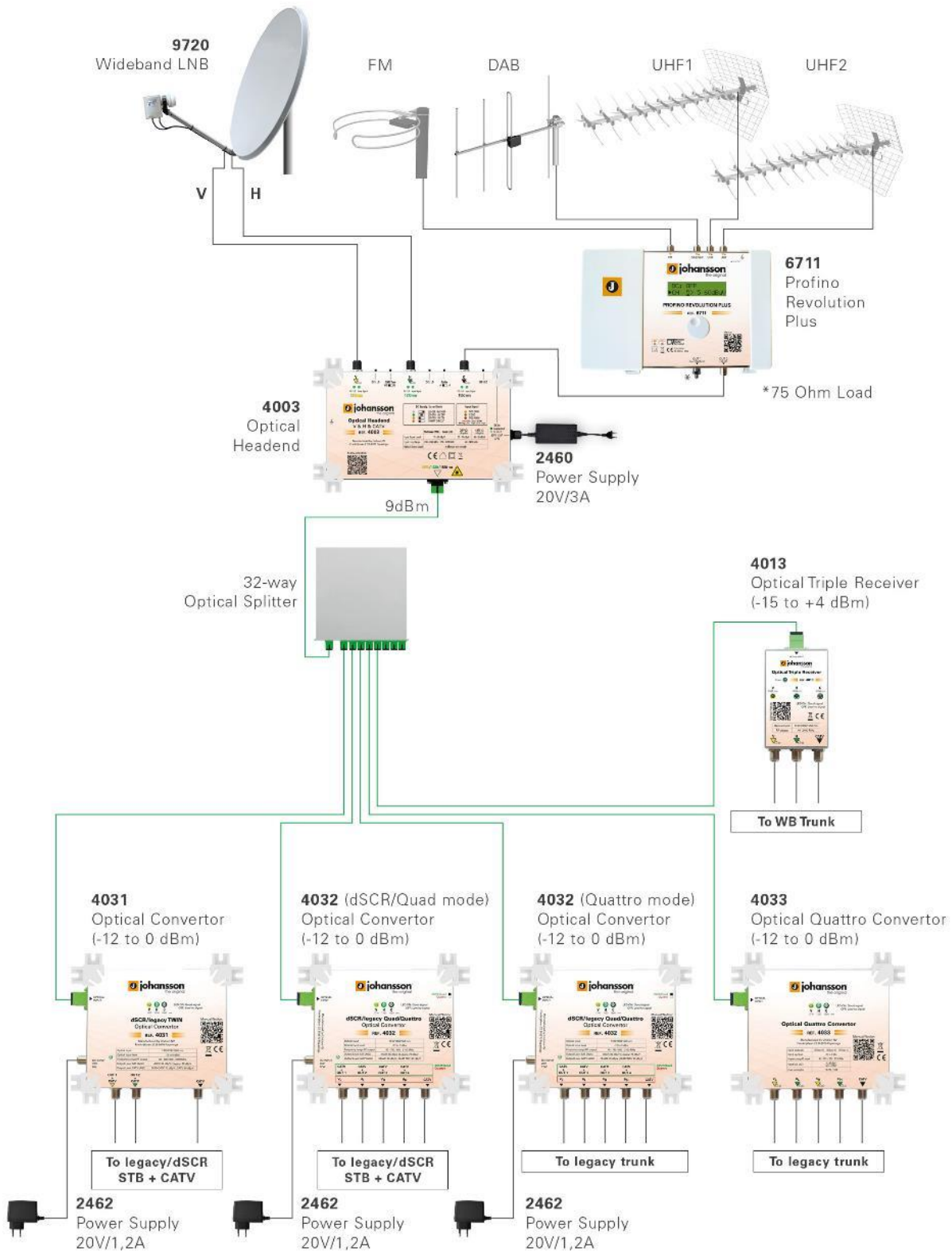

Wideband to SCR (up to 64 splits)

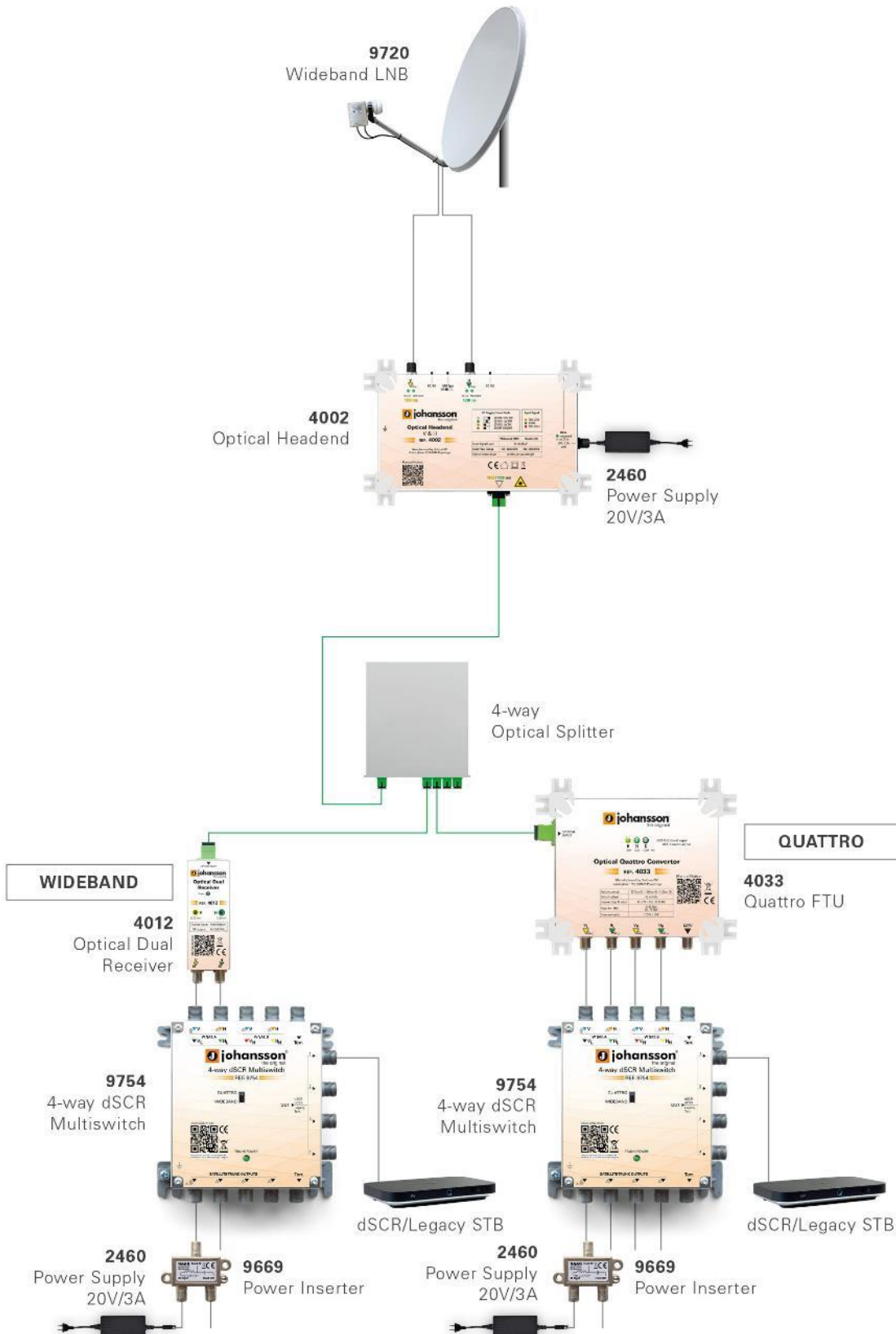

Hybrid dSCR Solution: Wideband to SCR + CATV (up to 64 splits)

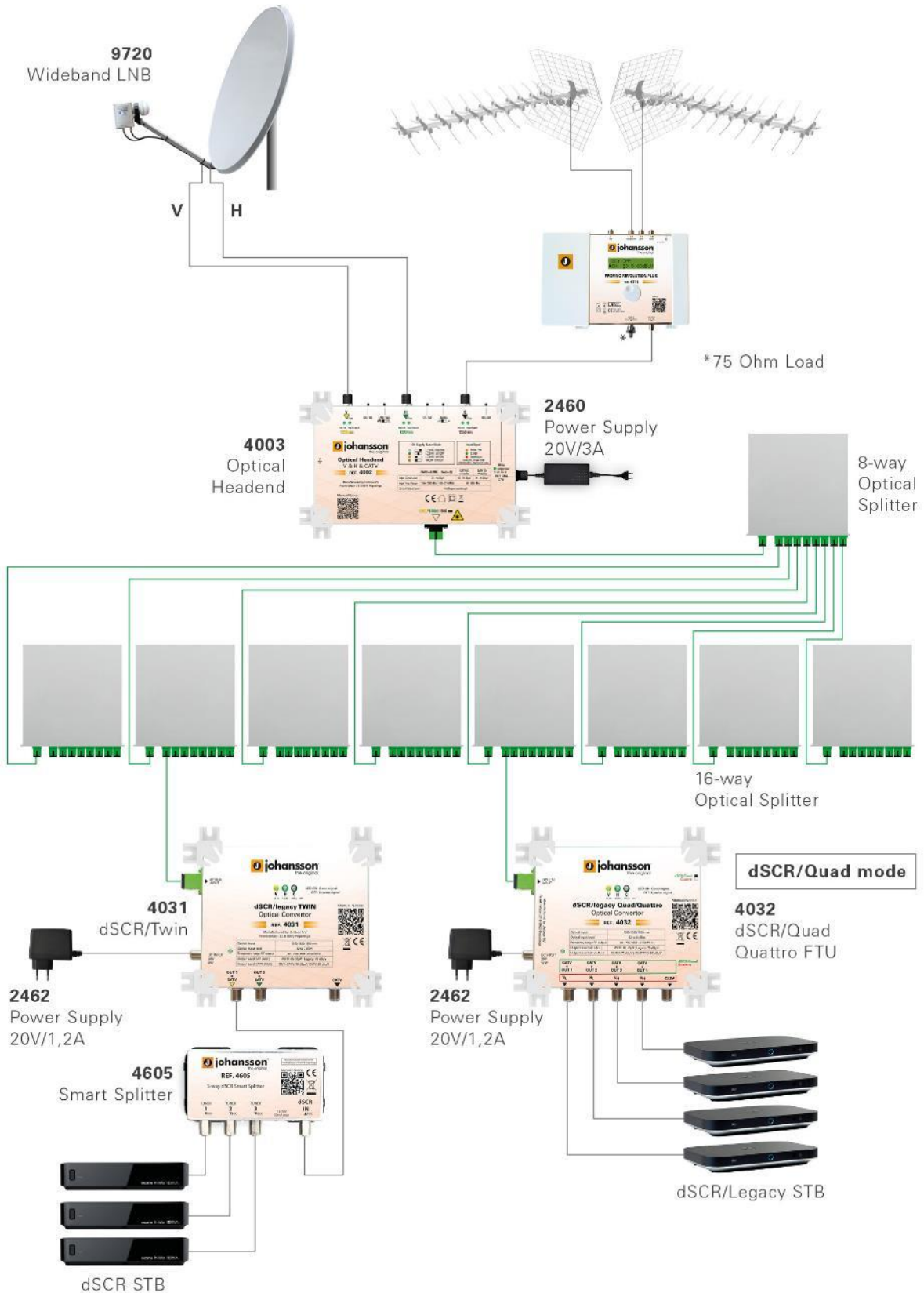

Legacy and dSCR: Wideband to SCR + CATV (up to 64 splits)

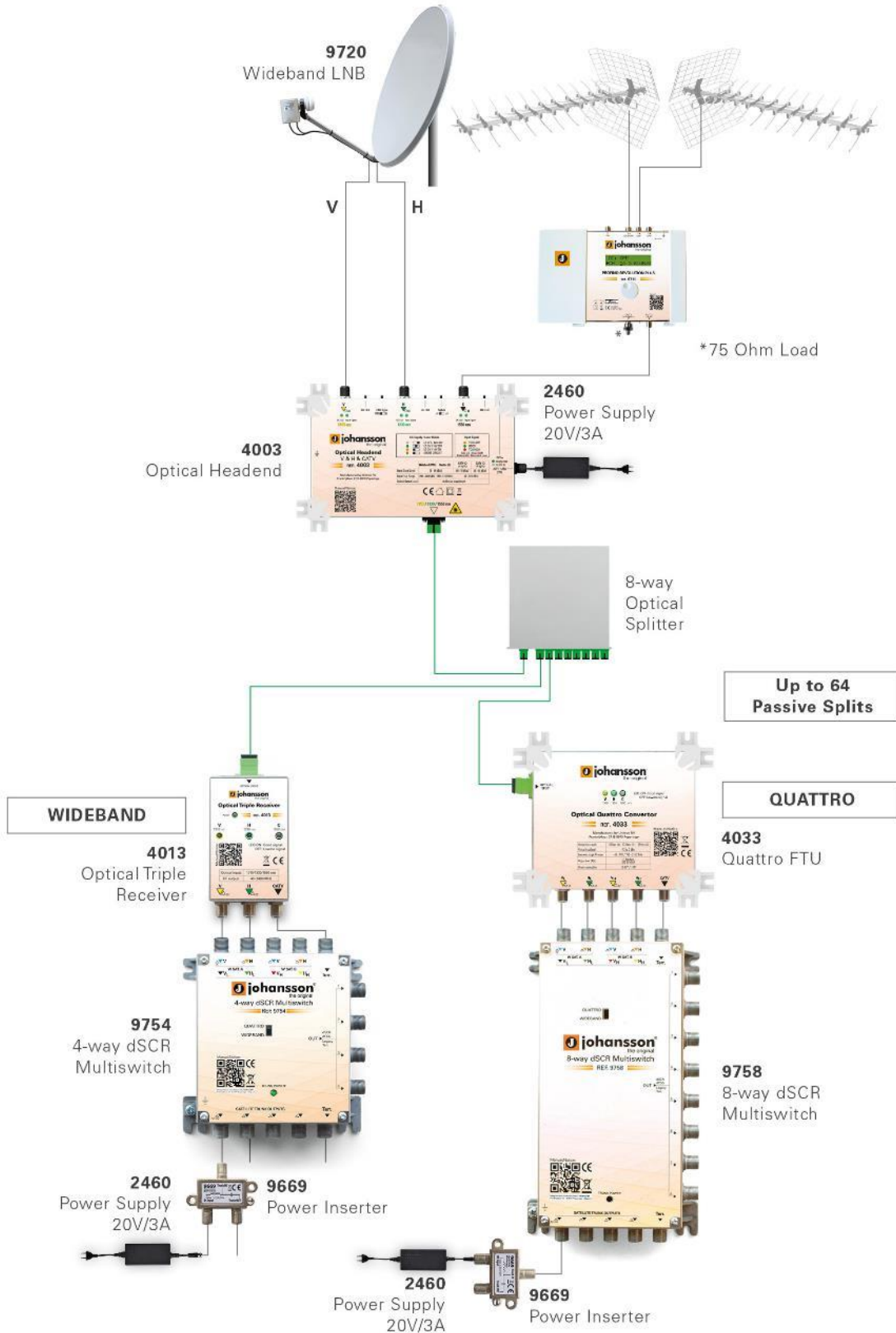

3. TECHNICAL SPECIFICATIONS REF 4031

Optical inputs	-	1
RF outputs	-	3 (2 dSCR/Legacy/CATV. + 1 CATV.)
Optical wavelengths	nm	1310 - 1330 - 1550
Frequency range	MHz	40 - 790 / 950 – 2150 (REF 4031) 40 - 862 / 950 – 2150 (REF 4031MC)
Optical input level	dBm	-12 to 0
Signal indicator	-	Green LED per wavelength
dCSS/dSCR UBs	-	2 x 16
Output level dSCR (AGC)	dB μ V	85
Output level Legacy (AGC)	dB μ V	78
Output level CATV (AGC)	dB μ V	Out + CATV: 70 CATV: 80
Return loss	dB	-10
Optical connector type	-	SC / APC
Output connector type	-	75 ohm F type (female)*
Band and polarity selection	-	DiSEqC 1.0 (unidirectional) DiSEqC 2.0 (bidirectional) Standard EN50494/EN50607 SKY UK protocol Universal LNB Voltage & Tone
Power consumption	W	8
Power supply via output (STB)	VDC	12 - 20
Power supply via DC IN	VDC	20
Power indicator	-	Green LED
Operating temperature range	°C	-10 to +55
Dimensions	mm	166 x 136 x 25
Weight	kg	0.310

*: Unused ports needs to be terminated with 75 Ohm DC-blocked terminator

4. TECHNICAL SPECIFICATIONS REF 4032

		4032 Quattro mode	4032 Quad mode
Optical inputs	-	1	
RF outputs	-	VL, HL, VH, HH, T	4 x dSCR/legacy + CATV.
Optical wavelengths	nm	1310 - 1330 - 1550	
Frequency range	MHz	40 - 790 / 950 – 2150 (REF 4032) 40 - 862 / 950 – 2150 (REF 4032MC)	
Optical input level	dBm	-12 to 0	
Signal indicator	-	Green LED per wavelength	
dCSS/dSCR UBs	-	-	4 x 16
Output level dSCR (AGC)	dB μ V	85	
Output level Legacy (AGC)	dB μ V	78	
Output level CATV (AGC)	dB μ V	80	70
Return loss	dB	10	
Input connector type	-	SC / APC	
Output connector type	-	75 ohm F type (female)*	
Band and polarity selection	-	DiSEqC 1.0 (unidirectional) DiSEqC 2.0 (bidirectional) Standard EN50494/EN50607 SKY UK protocol Universal LNB Voltage & Tone	
Power consumption	W	12	
Power supply via output (STB)	VDC	12 - 20	
Power supply via DC IN	VDC	20	
Power indicator	-	Green LED	
Operating temperature range	°C	-10 to +55	
Dimensions	mm	166 x 136 x 25	
Weight	kg	0.500	

*: Unused ports needs to be terminated with 75 Ohm DC-blocked terminator

5. TECHNICAL SPECIFICATIONS REF 4033 - 4036

		4033	4036
Optical inputs	-	1	
RF outputs	-	4 x Quattro (VL, HL, VH, HH) + 1 x CATV	
Optical wavelengths	nm	1310 - 1330 - 1550	1350 – 1370 – 1500
Frequency range	MHz	40 - 790 / 950 – 2150	
Optical input level	dBm	-12 to 0	
Signal indicator	-	Green LED per wavelength	
Output level dSCR (AGC)	dB μ V	78	
Output level CATV (AGC)	dB μ V	80	
Return loss	dB	-8 (typ -12)	
Input connector type	-	SC / APC	
Output connector type	-	75 ohm F type (female)*	
Power consumption	W	10	
Power supply via output (STB)	VDC	12 – 20	
Operating temperature range	°C	-10 to +55	
Dimensions	mm	166 x 136 x 25	
Weight	kg	0.5	

*: Unused ports needs to be terminated with 75 Ohm DC-blocked terminator

6. CHANNEL PLANS

REF 4031 and REF 4032

Sky UK		EN50607		EN50494	
UB	FREQ	UB	FREQ	UB	FREQ
3	1680	5	985	1	1210
9	1280	6	1050	2	1420
11	1380	7	1115	3	1680
14	1480	8	1275	4	2040
15	980	9	1340		
16	1030	10	1485		
17	1080	11	1550		
18	1130	12	1615		
19	1530	13	1745		
20	1580	14	1810		
21	1630	15	1875		
22	1730	16	1940		
23	1780				
24	1830				
25	1880				
26	1930				

REF 4031MC and REF 4032MC

Multichoice (MC)			
EN50494		EN50607	
UB	FREQ	UB	FREQ
1	1210	1	1210
2	1420	2	1420
3	1680	3	1680
4	2040	4	2040
5	1006	5	1006
6	1057	6	1057
7	1108	7	1108
8	1159	8	1159
		9	1261
		10	1312
		11	1363
		12	1471
		13	1522
		14	1573
		15	1624
		16	1731

7. SAFETY INSTRUCTIONS



Read these instructions carefully before connecting the unit



-  To prevent fire, short circuit or shock hazard:
 - Do not expose the unit to rain or moisture.
 - Install the unit in a dry location without infiltration or condensation of water.
 - Do not expose it to dripping or splashing.
 - Do not place objects filled with liquids, such as vases, on the apparatus.
 - If any liquid should accidentally fall into the cabinet, disconnect the power plug.

-  To avoid any risk of overheating:
 - Install the unit in a well aery location and keep a minimum distance of 15 cm around the apparatus for sufficient ventilation
 - Do not place any items such as newspapers, table-cloths, curtains, on the unit that might cover the ventilation holes.
 - Do not place any naked flame sources, such as lighted candles, on the apparatus
 - Do not install the product in a dusty place
 - Use the apparatus only in moderate climates (not in tropical climates)
 - Respect the minimum and maximum temperature specifications

-  To avoid any risk of electrical shocks:
 - Connect apparatus only to socket with protective earth connection.
 - The mains plug shall remain readily operable
 - Pull out power plug to make the different connections of cables
 - To avoid electrical shock, do not open the housing of adapter.



Maintenance

-  Only use a dry soft cloth to clean the cabinet.
-  Do not use solvent
-  For repairing and servicing refer to qualified personnel.



Dispose according your local authority's recycling processes

8. CONDITIONS OF WARRANTY

Unitron N.V. warrants the product as being free from defects in material and workmanship for a period of 24 months starting from the date of production indicated on it. See note below.

If during this period of warranty the product proves defective, under normal use, due to defective materials or workmanship, Unitron N.V, at its sole option, will repair or replace the product. Return the product to your local dealer for reparation.

THE WARRANTY IS APPLIED ONLY FOR DEFECTS IN MATERIAL AND WORKMANSHIP AND DOES NOT COVER DAMAGE RESULTING FROM:

- Misuse or use of the product out of its specifications,
- Installation or use in a manner inconsistent with the technical or safety standards in force in the country where the product is used,
- Use of non-suitable accessories (power supply, adapters...),
- Installation in a defect system,
- External cause beyond the control of Unitron N.V. such as drop, accidents, lightning, water, fire, improper ventilation...

THE WARRANTY IS NOT APPLIED IF

- Production date or serial number on the product is illegible, altered, deleted or removed.
- The product has been opened or repaired by a non-authorized person.

NOTE

Date of production can be found in the product's serial number code. The format will either be "YEAR W WEEK" (e.g., 2017W32 = year 2017 week 32) or "YYWW" (e.g., 1732 = year 2017 week 32).



www.unitrongroup.com

UNITRON NV
Frankrijklaan 27
B-8970 Poperinge
Belgium

T +32 57 33 33 63
F +32 57 33 45 24

sales@unitrongroup.com

www.unitrongroup.com